

NTQD6866R2

Power MOSFET 6.9 Amps, 20 Volts N-Channel TSSOP-8

Features

- New Low Profile TSSOP-8 Package
- Ultra Low $R_{DS(on)}$
- Higher Efficiency Extending Battery Life
- Logic Level Gate Drive
- Diode Exhibits High Speed, Soft Recovery
- Avalanche Energy Specified
- I_{DSS} and $V_{DS(on)}$ Specified at Elevated Temperatures
- Pb-Free Package is Available

Applications

- Power Management in Portable and Battery-Powered Products, i.e.: Computers, Printers, PCMCIA Cards, Cellular and Cordless Phones
- Battery Applications
- NoteBook PC

MAXIMUM RATINGS ($T_C = 25^\circ\text{C}$ unless otherwise noted)

Rating	Symbol	Value	Unit
Drain-to-Source Voltage	V_{DSS}	20	Vdc
Drain-to-Gate Voltage ($R_{GS} = 1.0\text{ M}\Omega$)	V_{DGR}	20	Vdc
Gate-to-Source Voltage - Continuous	V_{GS}	± 12	Vdc
Thermal Resistance - Single Die Junction-to-Ambient (Note 1)	$R_{\theta JA}$	62.5	$^\circ\text{C}/\text{W}$
Total Power Dissipation @ $T_A = 25^\circ\text{C}$	P_D	2.0	W
Continuous Drain Current @ $T_A = 25^\circ\text{C}$	I_D	6.9	A dc
Pulsed Drain Current (Note 4)	I_{DM}	24	A dc
Thermal Resistance - Single Die Junction-to-Ambient (Note 2)	$R_{\theta JA}$	88	$^\circ\text{C}/\text{W}$
Total Power Dissipation @ $T_A = 25^\circ\text{C}$	P_D	1.42	W
Continuous Drain Current @ $T_A = 25^\circ\text{C}$	I_D	5.8	A dc
Continuous Drain Current @ $T_A = 70^\circ\text{C}$	I_D	4.6	A dc
Pulsed Drain Current (Note 4)	I_{DM}	20	A dc
Thermal Resistance - Single Die Junction-to-Ambient (Note 3)	$R_{\theta JA}$	132	$^\circ\text{C}/\text{W}$
Total Power Dissipation @ $T_A = 25^\circ\text{C}$	P_D	0.94	W
Continuous Drain Current @ $T_A = 25^\circ\text{C}$	I_D	4.7	A dc
Continuous Drain Current @ $T_A = 70^\circ\text{C}$	I_D	3.8	A dc
Pulsed Drain Current (Note 4)	I_{DM}	14	A dc
Operating and Storage Temperature Range	T_J, T_{stg}	-55 to +150	$^\circ\text{C}$
Single Pulse Drain-to-Source Avalanche Energy - Starting $T_J = 25^\circ\text{C}$ ($V_{DD} = 20\text{ Vdc}$, $V_{GS} = 5.0\text{ Vdc}$, Peak $I_L = 5.5\text{ Apk}$, $L = 10\text{ mH}$, $R_G = 25\ \Omega$)	E_{AS}	150	mJ
Maximum Lead Temperature for Soldering Purposes for 10 seconds	T_L	260	$^\circ\text{C}$

Stresses exceeding Maximum Ratings may damage the device. Maximum Ratings are stress ratings only. Functional operation above the Recommended Operating Conditions is not implied. Extended exposure to stresses above the Recommended Operating Conditions may affect device reliability.

1. Mounted onto a 2" square FR-4 board
(1 in sq, 2 oz Cu 0.06" thick single-sided), $t < 10$ seconds.
2. Mounted onto a 2" square FR-4 board
(1 in sq, 2 oz Cu 0.06" thick single-sided), $t = ss$.
3. Minimum FR-4 or G-10 PCB, $t = \text{steady state}$.
4. Pulse Test: Pulse Width = 300 μs , Duty Cycle = 2%.



ON Semiconductor®

<http://onsemi.com>

**6.9 AMPERES
20 VOLTS
30 m Ω @ $V_{GS} = 4.5\text{ V}$**

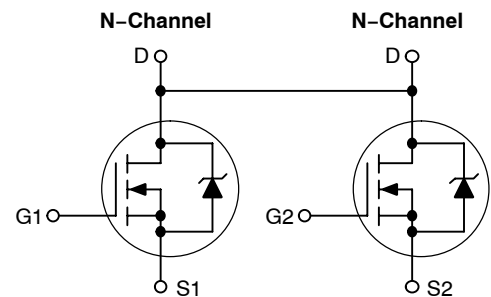

MARKING DIAGRAM & PIN ASSIGNMENT

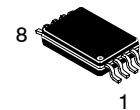

**TSSOP-8
CASE 948S
PLASTIC**

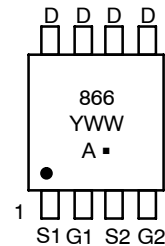

866 = Specific Device Code
A = Assembly Location
Y = Year
WW = Work Week
▪ = Pb-Free Package

ORDERING INFORMATION

Device	Package	Shipping†
NTQD6866R2	TSSOP-8	4000/Tape & Reel
NTQD6866R2G	TSSOP-8 (Pb-Free)	4000/Tape & Reel

†For information on tape and reel specifications, including part orientation and tape sizes, please refer to our Tape and Reel Packaging Specifications Brochure, BRD8011/D

NTQD6866R2

ELECTRICAL CHARACTERISTICS (T_C = 25°C unless otherwise noted)

Characteristic	Symbol	Min	Typ	Max	Unit
OFF CHARACTERISTICS					
Drain-to-Source Breakdown Voltage (V _{GS} = 0 Vdc, I _D = 250 μAdc) Temperature Coefficient (Positive)	V _{(BR)DSS}	20 -	- 18.5	- -	Vdc mV/°C
Zero Gate Voltage Drain Current (V _{GS} = 0 Vdc, V _{DS} = 20 Vdc, T _J = 25°C) (V _{GS} = 0 Vdc, V _{DS} = 20 Vdc, T _J = 100°C)	I _{DSS}	- -	- -	1.0 10	μAdc
Gate-Body Leakage Current (V _{GS} = ±12 Vdc, V _{DS} = 0 Vdc)	I _{GSS}	-	-	±100	nAdc

ON CHARACTERISTICS

Gate Threshold Voltage (V _{DS} = V _{GS} , I _D = 250 μAdc) Temperature Coefficient (Negative)	V _{GS(th)}	0.6 -	0.9 -2.7	1.2 -	Vdc mV/°C
Static Drain-to-Source On-State Resistance (V _{GS} = 4.5 Vdc, I _D = 6.9 Adc) (V _{GS} = 4.5 Vdc, I _D = 5.8 Adc) (V _{GS} = 2.5 Vdc, I _D = 3.5 Adc) (V _{GS} = 2.5 Vdc, I _D = 2.9 Adc)	R _{DS(on)}	- - - -	0.026 0.025 0.030 0.030	0.032 0.030 0.038 0.038	Ω
Forward Transconductance (V _{DS} = 10 Vdc, I _D = 5.8 Adc)	g _{FS}	-	14	-	Mhos

DYNAMIC CHARACTERISTICS

Input Capacitance	(V _{DS} = 16 Vdc, V _{GS} = 0 Vdc, f = 1.0 MHz)	C _{iss}	-	875	1400	pF
Output Capacitance		C _{oss}	-	325	550	
Reverse Transfer Capacitance		C _{rss}	-	100	175	

SWITCHING CHARACTERISTICS (Note 5)

Turn-On Delay Time	(V _{DD} = 16 Vdc, I _D = 5.8 Adc, V _{GS} = 4.5 Vdc, R _G = 6.0 Ω)	t _{d(on)}	-	10	18	ns
Rise Time		t _r	-	45	80	
Turn-Off Delay Time		t _{d(off)}	-	40	75	
Fall Time		t _f	-	90	150	
Turn-On Delay Time	(V _{DD} = 16 Vdc, I _D = 5.8 Adc, V _{GS} = 4.5 Vdc, R _G = 3.0 Ω)	t _{d(on)}	-	8.0	-	
Rise Time		t _r	-	45	-	
Turn-Off Delay Time		t _{d(off)}	-	35	-	
Fall Time		t _f	-	75	-	
Gate Charge	(V _{DS} = 16 Vdc, V _{GS} = 4.5 Vdc, I _D = 5.8 Adc)	Q _{tot}	-	13	22	nC
		Q _{gs}	-	1.8	-	
		Q _{gd}	-	4.5	-	

BODY-DRAIN DIODE RATINGS

Forward On-Voltage	(I _S = 5.8 Adc, V _{GS} = 0 Vdc) (I _S = 5.8 Adc, V _{GS} = 0 Vdc, T _J = 100°C)	V _{SD}	- -	0.85 0.75	1.0 -	Vdc
Reverse Recovery Time	(I _S = 5.8 Adc, V _{GS} = 0 Vdc, V _{DS} = 20 Vdc dI _S /dt = 100 A/μs)	t _{rr}	-	23	-	ns
		t _b	-	11	-	
		t _a	-	12	-	
Reverse Recovery Stored Charge		Q _{RR}	-	0.013	-	μC

5. Switching characteristics are independent of operating junction temperature.

NTQD6866R2

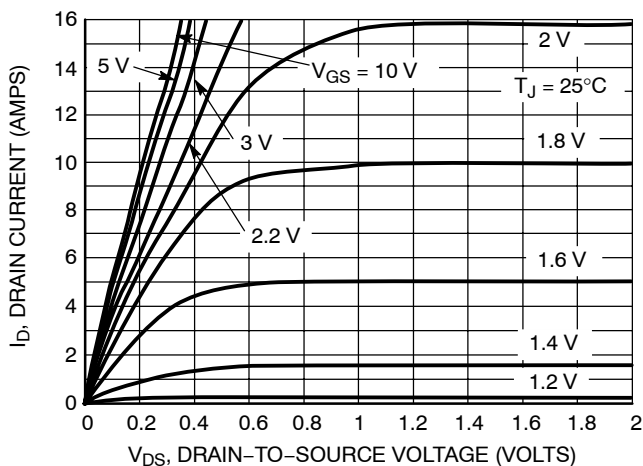

Figure 1. On-Region Characteristics

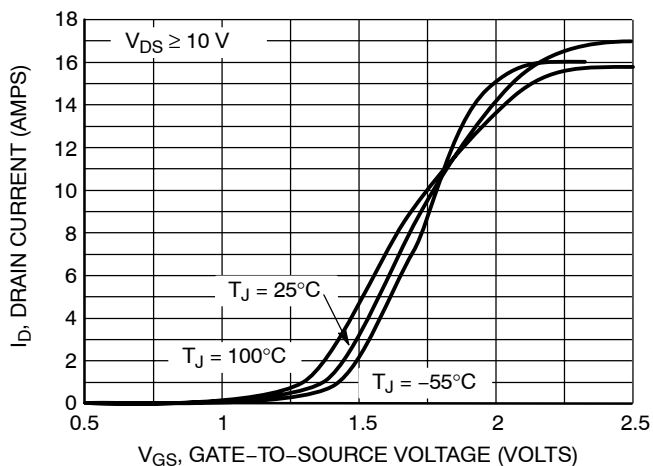

Figure 2. Transfer Characteristics

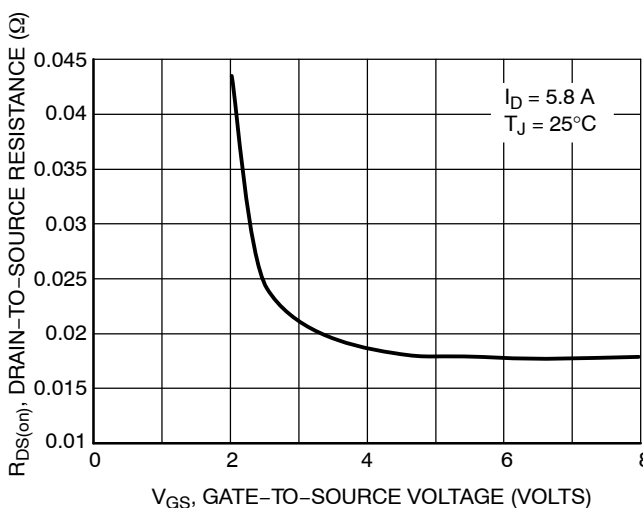

Figure 3. On-Resistance versus Gate-to-Source Voltage

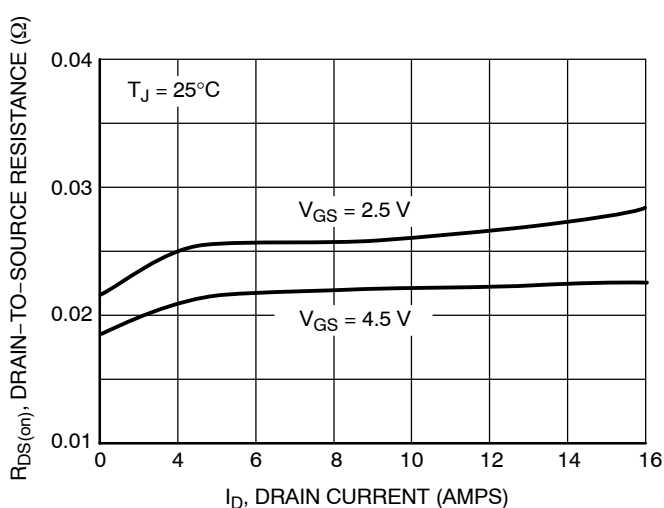

Figure 4. On-Resistance versus Drain Current and Gate Voltage

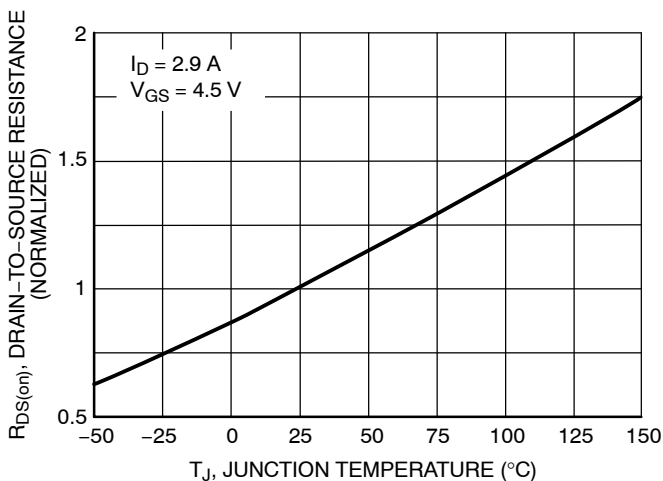

Figure 5. On-Resistance Variation with Temperature

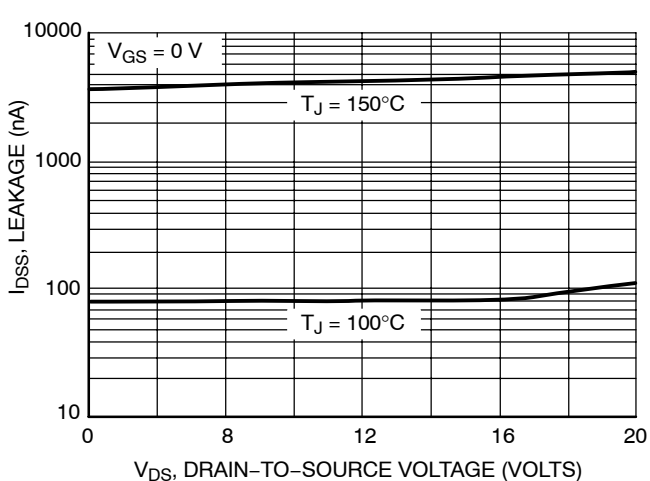

Figure 6. Drain-to-Source Leakage Current versus Voltage

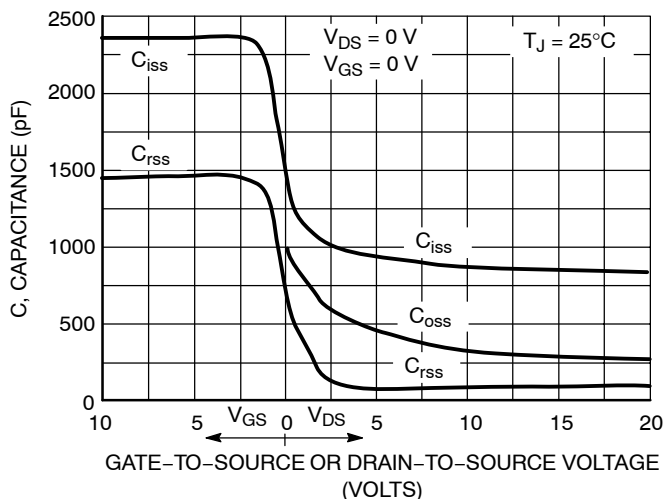

Figure 7. Capacitance Variation

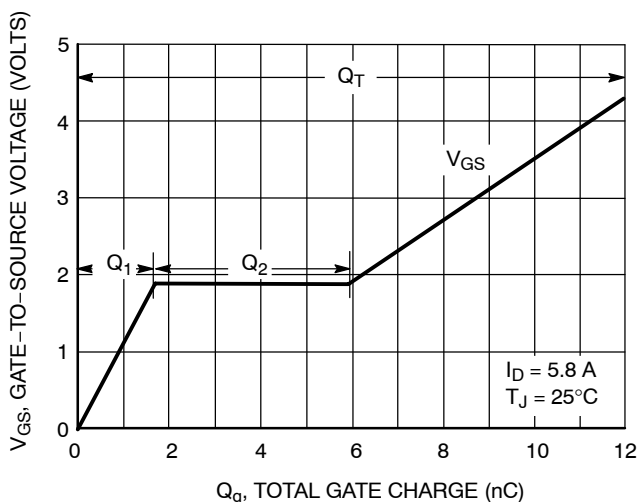

Figure 8. Gate-to-Source Voltage versus Total Charge

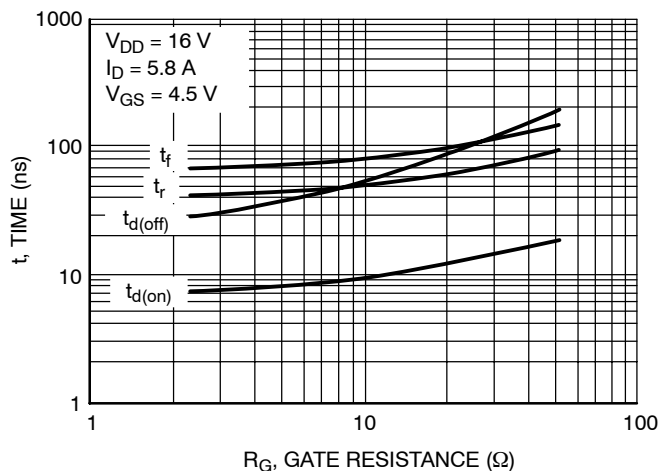

Figure 9. Resistive Switching Time Variation versus Gate Resistance

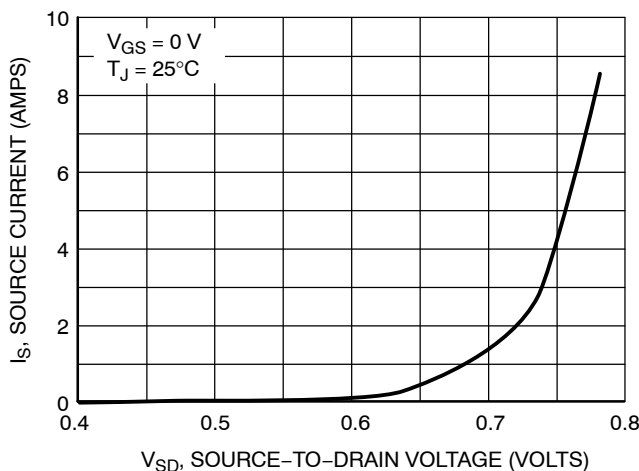

Figure 10. Diode Forward Voltage versus Current

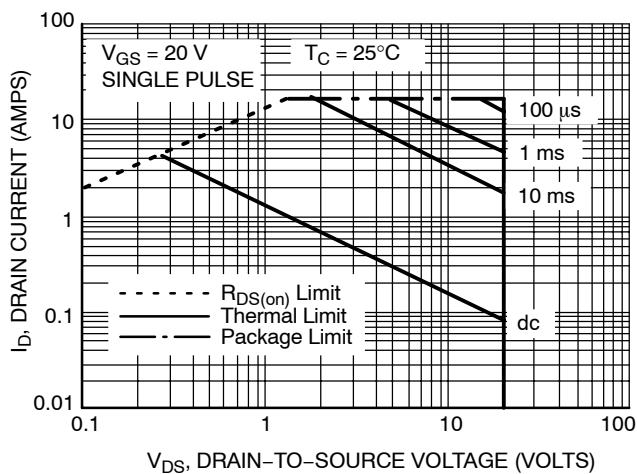

Figure 11. Maximum Rated Forward Biased Safe Operating Area

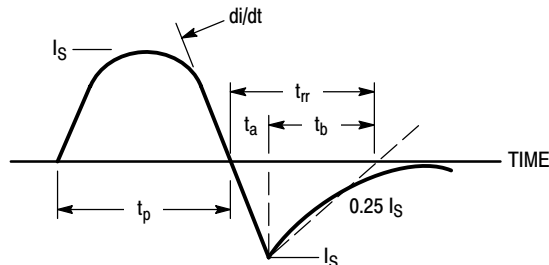

Figure 12. Diode Reverse Recovery Waveform

NTQD6866R2

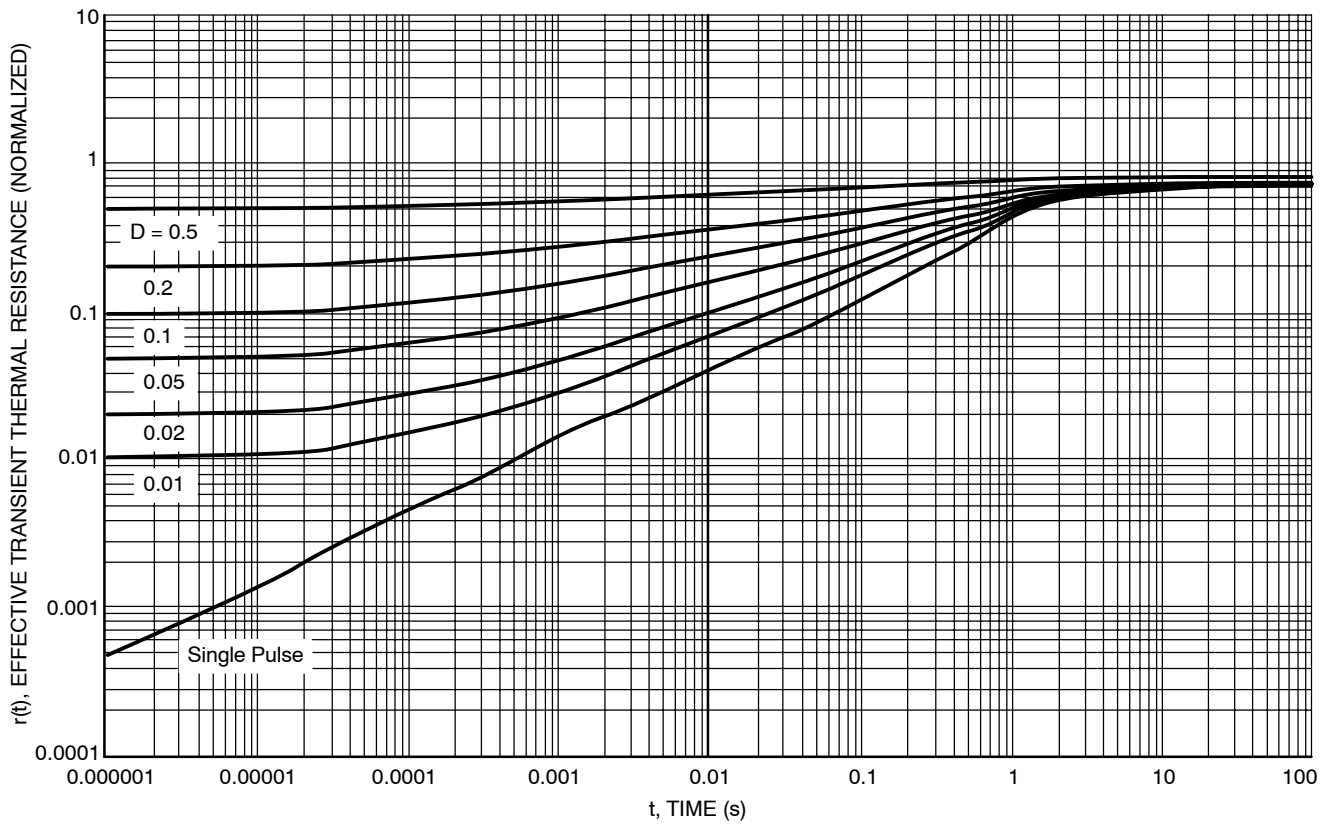
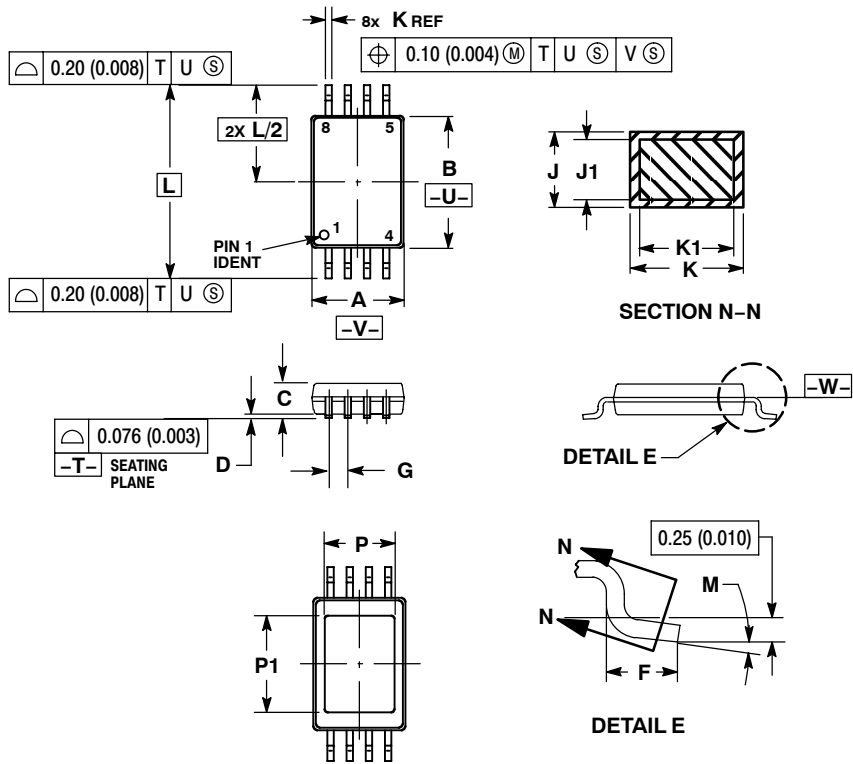

Figure 13. Thermal Response

NTQD686R2

PACKAGE DIMENSIONS

TSSOP-8 CASE 948S-01 ISSUE A



NOTES:

1. DIMENSIONING AND TOLERANCING PER ANSI Y14.5M, 1982.
2. CONTROLLING DIMENSION: MILLIMETER.
3. DIMENSION A DOES NOT INCLUDE MOLD FLASH, PROTRUSIONS OR GATE BURRS. MOLD FLASH OR GATE BURRS SHALL NOT EXCEED 0.15 (0.006) PER SIDE.
4. DIMENSION B DOES NOT INCLUDE INTERLEAD FLASH OR PROTRUSION. INTERLEAD FLASH OR PROTRUSION SHALL NOT EXCEED 0.25 (0.010) PER SIDE.
5. TERMINAL NUMBERS ARE SHOWN FOR REFERENCE ONLY.
6. DIMENSION A AND B ARE TO BE DETERMINED AT DATUM PLANE -W-.

DIM	MILLIMETERS		INCHES	
	MIN	MAX	MIN	MAX
A	2.90	3.10	0.114	0.122
B	4.30	4.50	0.169	0.177
C	---	1.10	---	0.043
D	0.05	0.15	0.002	0.006
F	0.50	0.70	0.020	0.028
G	0.65 BSC		0.026 BSC	
J	0.09	0.20	0.004	0.008
J1	0.09	0.16	0.004	0.006
K	0.19	0.30	0.007	0.012
K1	0.19	0.25	0.007	0.010
L	6.40 BSC		0.252 BSC	
M	0°	8°	0°	8°
P	---	2.20	---	0.087
P1	---	3.20	---	0.126

SOLDERING FOOTPRINT*

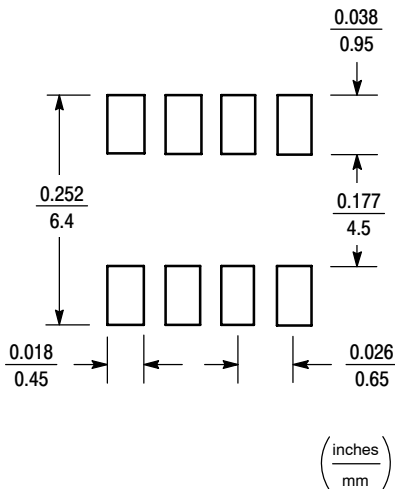

*For additional information on our Pb-Free strategy and soldering details, please download the ON Semiconductor Soldering and Mounting Techniques Reference Manual, SOLDERRM/D.

ON Semiconductor and  are registered trademarks of Semiconductor Components Industries, LLC (SCILLC). SCILLC reserves the right to make changes without further notice to any products herein. SCILLC makes no warranty, representation or guarantee regarding the suitability of its products for any particular purpose, nor does SCILLC assume any liability arising out of the application or use of any product or circuit, and specifically disclaims any and all liability, including without limitation special, consequential or incidental damages. "Typical" parameters which may be provided in SCILLC data sheets and/or specifications can and do vary in different applications and actual performance may vary over time. All operating parameters, including "Typicals" must be validated for each customer application by customer's technical experts. SCILLC does not convey any license under its patent rights nor the rights of others. SCILLC products are not designed, intended, or authorized for use as components in systems intended for surgical implant into the body, or other applications intended to support or sustain life, or for any other application in which the failure of the SCILLC product could create a situation where personal injury or death may occur. Should Buyer purchase or use SCILLC products for any such unintended or unauthorized application, Buyer shall indemnify and hold SCILLC and its officers, employees, subsidiaries, affiliates, and distributors harmless against all claims, costs, damages, and expenses, and reasonable attorney fees arising out of, directly or indirectly, any claim of personal injury or death associated with such unintended or unauthorized use, even if such claim alleges that SCILLC was negligent regarding the design or manufacture of the part. SCILLC is an Equal Opportunity/Affirmative Action Employer. This literature is subject to all applicable copyright laws and is not for resale in any manner.

PUBLICATION ORDERING INFORMATION

LITERATURE FULFILLMENT:

Literature Distribution Center for ON Semiconductor
P.O. Box 61312, Phoenix, Arizona 85082-1312 USA
Phone: 480-829-7710 or 800-344-3860 Toll Free USA/Canada
Fax: 480-829-7709 or 800-344-3867 Toll Free USA/Canada
Email: orderlit@onsemi.com

N. American Technical Support: 800-282-9855 Toll Free
USA/Canada

Japan: ON Semiconductor, Japan Customer Focus Center
2-9-1 Kamimeguro, Meguro-ku, Tokyo, Japan 153-0051
Phone: 81-3-5773-3850

ON Semiconductor Website: <http://onsemi.com>

Order Literature: <http://www.onsemi.com/litorder>

For additional information, please contact your
local Sales Representative.